

Compliant with European Application Refrigerants (EC 1005/2009), the Montreal Protocol, and the US EPA SNAP

Benefits

- -120 to -145C (153 to 128K)
- Heat Removal to 2500 watts
- Cryocondenses Water Vapor in Vacuum Systems with Speeds to 140,000 l/sec Vacuum levels to 8×10^{-10} torr (1×10^{-9} mbar)
- Theoretical maximum pumping speed 208,600 l/s
- Increased productivity with rapid cool to cool
- Option for power management to minimize cost of ownership
- Temperature control
- Patented Green refrigerant charge is globally compliant, non-toxic, and non-flammable
- Based on Polycold's proven, innovative, dependable mixed gas refrigeration
- Compliant to EU PED, MD and ROHS
- TUV Rheinland Listed to NRTL/CANADA Safety Standards
- ISO 9001:2008 certified manufacturer

The Polycold MaxCool 2500 L cryochiller is a closed loop cryogenic refrigeration system that provides up to 2,500 watts of cooling. It can be used to capture water vapor and other condensable substances by freezing them onto a cold surface such as a cryocoil or chevron baffle. The MaxCool 2500 L cryochiller is also used to cool and heat objects such as electrostatic chucks used in semiconductor wafer processing.

Water Vapor Pumping

The Polycold MaxCool 2500 L cryochiller effectively captures water vapor, which comprises 65% to 95% of the residual gas in high vacuum systems. Water vapor is typically the most reactive contaminant present. With the MaxCool Cryochiller, you can expect to increase product throughput in your existing system 20% to 100% and improve quality of deposition.

The MaxCool Advantage

- High-vacuum pumpdown time cut by up to 75%
- High-speed pumping of water vapor: 10,000 to 140,000 l/sec in the workspace
- Increased product throughput of 20% to 100%
- Lower water vapor partial pressure during processing for higher film quality, better adhesion and more reproducible deposition
- Superior in cost/performance to liquid nitrogen cooled Meissners
- Minimize cost of ownership with power management
- High capacity cooling and heating for a wide variety of processes

When added to your vacuum system, the MaxCool Cryochiller can dramatically reduce pumpdown times and increase product throughput. The MaxCool will pump water vapor within minutes from "start" and can defrost in less than four minutes, giving true fast-cycle capability. It also has an option called Rapid Cool to Cool which eliminates the waiting period after defrost. For your system, this means more production cycles per shift.

Using patented Polycold® refrigerant mixtures, the MaxCool works on the principle of Meissner trapping. Water vapor is captured by condensation on a cryogenically cooled surface, called a Meissner coil. The Meissner (cryocoil) is mounted directly in the vacuum chamber so conductance is not limited by ports, manifolds, valves, and baffles. The cryocoil is easy to install and can be adapted to fit any system. It does not need a high vacuum valve.

MaxCool Cryochillers are the most cost effective upgrade that you can add to any diffusion-pumped, turbo-pumped, or helium-cryopumped system.



Polycold® MaxCool 2500 L

Frequently Asked Applications Questions

How do I select the right model of MaxCool to trap water vapor in my vacuum chamber?

Determining the appropriate MaxCool system depending upon the desired water vapor pumping speed and the ability of the chamber to accommodate the required amount of cold element (cryocoil) surface area. The larger the cryocoil, the greater the pumping speed. Typically, we recommend an increase in chamber net speed of four times the existing (net in-chamber) water vapor pumping speed. This typically results in a pumpdown time reduction from 25% to 75%. Once the approximate unit size and cryocoil surface area have been established, the required temperature and cooling capacity of the system are reviewed against the presence of any additional heat load (long refrigerant lines, process heat, etc.).

Can I also use the MaxCool cryochiller for thermal management?

The MaxCool cryochiller cools components in a wide variety of process steps in diverse markets such as semiconductor, flat panel display, data storage and space simulation. Applications include refrigerant-cooled chucks or platens that regulate the temperature of substrates during manufacturing processes. The MaxCool cryochiller can also cool an external heat exchanger for open-loop or closed-loop gas chilling processes. The Thermal Package includes advanced thermal management features such as temperature setpoint control, temperature ramp rate control, and process heating.

What's the best temperature to trap water vapor effectively?

To find the cryosurface temperature that is best for your vacuum system, find the ultimate base pressure of your system listed below. This temperature provides 90% water vapor trapping efficiency.

DESIRED WATER VAPOR PARTIAL PRESSURE		AVERAGE CRYOSURFACE TEMPERATURE NEEDED	DESIRED WATER VAPOR PARTIAL PRESSURE		AVERAGE CRYOSURFACE TEMPERATURE NEEDED
torr	mbar	°C	torr	mbar	°C
5 x 10 ⁰	6.7 x 10 ⁰	-25.4	5 x 10 ⁻⁵	6.7 x 10 ⁻⁵	-104.9
2 x 10 ⁰	2.7 x 10 ⁰	-34.4	2 x 10 ⁻⁵	2.7 x 10 ⁻⁵	-109.1
1 x 10 ⁰	1.3 x 10 ⁰	-40.8	1 x 10 ⁻⁵	1.3 x 10 ⁻⁵	-112.2
5 x 10 ⁻¹	6.7 x 10 ⁻¹	-46.8	5 x 10 ⁻⁶	6.7 x 10 ⁻⁶	-115.1
2 x 10 ⁻¹	2.7 x 10 ⁻¹	-54.3	2 x 10 ⁻⁶	2.7 x 10 ⁻⁶	-118.1
1 x 10 ⁻¹	1.3 x 10 ⁻¹	-59.7	1 x 10 ⁻⁶	1.3 x 10 ⁻⁶	-121.5
5 x 10 ⁻²	6.7 x 10 ⁻²	-64.8	5 x 10 ⁻⁷	6.7 x 10 ⁻⁷	-124.1
2 x 10 ⁻²	2.7 x 10 ⁻²	-71.2	2 x 10 ⁻⁷	2.7 x 10 ⁻⁷	-127.5
1 x 10 ⁻²	1.3 x 10 ⁻²	-75.8	1 x 10 ⁻⁷	1.3 x 10 ⁻⁷	-129.9
5 x 10 ⁻³	6.7 x 10 ⁻³	-80.1	5 x 10 ⁻⁸	6.7 x 10 ⁻⁸	-132.2
2 x 10 ⁻³	2.7 x 10 ⁻³	-85.6	2 x 10 ⁻⁸	2.7 x 10 ⁻⁸	-135.2
1 x 10 ⁻³	1.3 x 10 ⁻³	-89.6	1 x 10 ⁻⁸	1.3 x 10 ⁻⁸	-137.3
5 x 10 ⁻⁴	6.7 x 10 ⁻⁴	-93.4	5 x 10 ⁻⁹	6.7 x 10 ⁻⁹	-139.5
2 x 10 ⁻⁴	2.7 x 10 ⁻⁴	-98.2	2 x 10 ⁻⁹	2.7 x 10 ⁻⁹	-142.1
1 x 10 ⁻⁴	1.3 x 10 ⁻⁴	-101.6	1 x 10 ⁻⁹	1.3 x 10 ⁻⁹	-144.1

Key System Components

1 CRYOCOIL

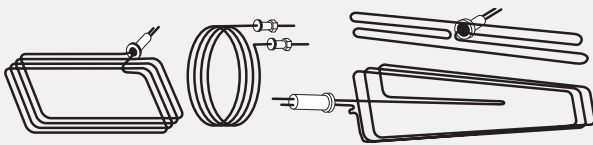

The cryocoil will be designed to fit the specific vacuum chamber, based on information you supply, or you may choose to design and build your own cryocoil. Typical cryocoils have helical, spiral, serpentine or other simple shapes. We do not recommend cryopanel, due to slow cool/defrost times as a result of their increased mass and ineffective cryopumping on the rear side when positioned near the chamber wall. A stainless steel cryocoil, a complex cryocoil design or an adapter flange, may require additional costs.

2 FEEDTHROUGH

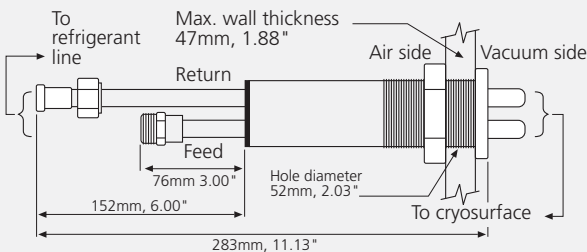

The standard cryogenic feedthrough provides thermal isolation between the feed/return tubes and the O-ring seal. The dual-pass feedthrough requires a two-inch diameter hole in the vacuum chamber. Couplings on the feed through mate with the refrigerant line. Optional feedthroughs fit one-inch diameter holes, but two are required (one for each tube). Custom feedthroughs are available.

3 REFRIGERANT LINE

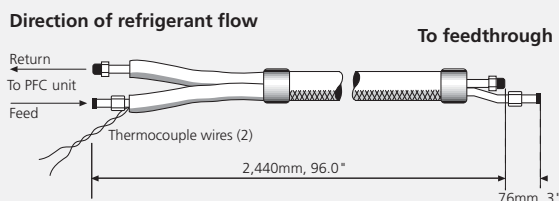

A standard refrigerant line set consists of a copper feed and return line, each with stainless steel couplings on both ends for connection to the XC unit and to the feedthrough. Longer lengths of refrigerant line (more than the standard 8 feet (2.44m) can be ordered from the factory, but will require our applications review.

Interface

Every MaxCool unit has RS-232 and a gauge port relay installed as standard. Each unit also includes a manual human machine interface, with a display and a keypad for navigation and selection.

There is an option for either a 24V DI/DO remote. Ethernet, Profibus, or DeviceNet.

Features

The MaxCool Cryochiller has the following features common to all models.

Rapid Balance Pressure Check: With this feature, the MaxCool unit can give a balance pressure reading in about 20 minutes, rather than the 48-hour warm-up required by the previous PFC models. This improvement maximizes tool uptime.

Self-Diagnostics: All models of the MaxCool Cryochiller include self-diagnostics to assist the user.

Footprint: Minor service access is needed from only the front, and major service access is needed from only the front and back, making the unit easier to position.

Compliance: The MaxCool Cryochiller is compliant to EU PED, MD and ROHS. TUV Rheinland listed to NRTL/Canada safety standards. Semi S2, Semi F47, and EMO (emergency stop) compliance are dependant on system configuration.

Options

Ethernet: Available as an option.

Profibus: Available as an option.

DeviceNet: Available as an option.

24V DI/DO Remote: The MaxCool has an option for a 24V DI/DO remote, which allows for direct wiring for inputs to and outputs from the MaxCool Cryochiller in a manner similar to earlier PFC models. The 24V DI/DO may be Isolated or Non-Isolated and may be for a Single Circuit or Dual Circuit system. Two set point relays are included.

Rapid Cool to Cool: Zero recovery time is required after completing a defrost cycle and the MaxCool Cryochiller is immediately ready to begin the next cool down cycle.

Power Management: All MaxCool models consume in standby approximately half of the power they consume at maximum load. This Power Management option allows additional savings up to 15% in standby and 25% while cooling, as long as the full cooling capacity is not needed.

Casters: Allows for ease of unit installation and removal.

Lifting rings: Allows for ease in moving the unit.

Thermal Package: Process Heating, Temperature Control, and four additional user-assignable thermocouples.

Dual Circuit: Enables the MaxCool to cool two cryosurfaces (two cryocoils, coil and baffle, or two baffles) which can be cooled or defrosted separately.

Helpful Information for Sizing Systems

Radiation Heat Load on Cryocoil

- (At 25°C Ambient Conditions) -376.6 watts/m² (35 watts/ft²)
- Refrigerant Line Heat Load -26.3 watts/m (8 watts/ft)
- Vacuum Jacketed Line Heat Load -1.0 watts/m (0.3 watts/ft)
- Water Vapor Pumping Speed (Theoretical) - 149,000 l/s/m² (13,842 l/s/ft²)
- Liquid Nitrogen Cooling Approximately (45 watts/liter/hour)

Crypumping Speed as a Function of Water Vapor Partial Pressure

MaxCool 2500 L

Pumping Speed, Liters per second

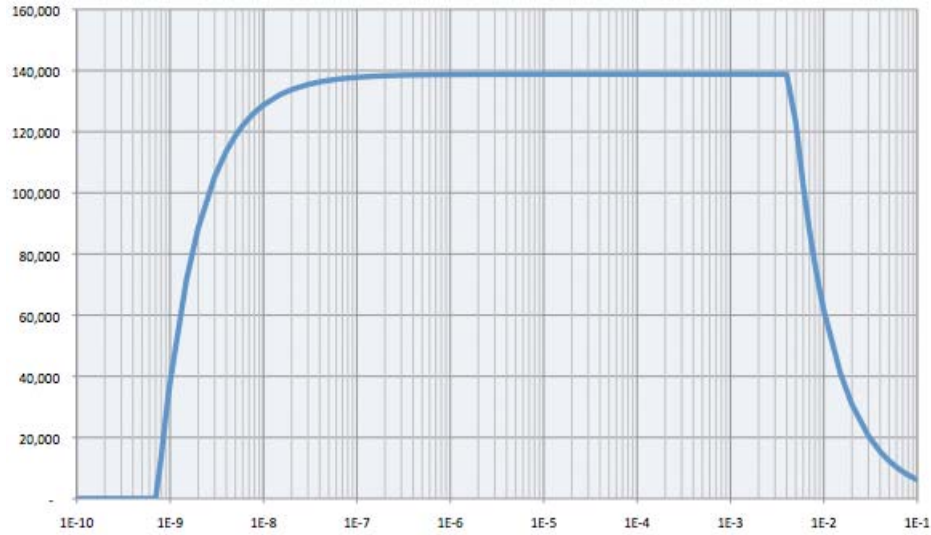

Water Vapor Partial Pressure, Torr

NOTE: For some operating conditions the cryocoils may be enlarged to provide greater pumping speeds

Average Cryosurface Temperature as a Function of Applied Heat Load

MaxCool 2500 L

Average Cryosurface Temperature (°C)

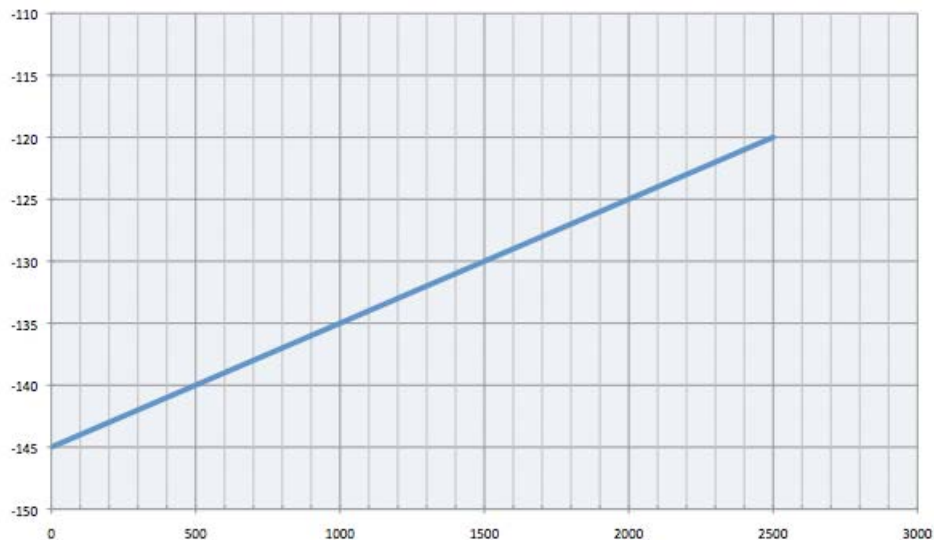

Applied Heat Load (W)

- NOTE: 1. Temperatures shown are the average of the inlet and outlet using recommended cryocoil size. The temperature differences between inlet and outlet are typically 20°C at Maximum load.
2. The end point of each curve is the maximum load for that model.
3. Performance at 50 Hz is typically 3 to 5°C warmer than the 60 Hz performance shown

MaxCool Specifications

2500 L

Typical Performance^a

Maximum Load (Watts at warmest temperature)	2500
Theoretical max pumping speed l/sec ^b	208,600
Conservative pumping speed (in chamber) l/sec ^b	140,000
Ultimate Operating Pressure, torr ^c	8 x 10 ⁻¹⁰
Ultimate Operating Pressure, mbar	1 x 10 ⁻⁹
Maximum pump start pressure, atm ^d	1.0
Time to defrost, minutes	4.0 ^h

Cryocoils and Refrigerant Lines

Total Cryocoil Surface area m ² (ft. ²)	1.4 (15.1)
Single Circuit	
Tube O.D., mm (in.)	16 (5/8)
Tube Length m (ft.)	27.9 (92.1)
Dual Circuit	
Tube O.D., mm (in.)	12 (1/2)
Tube Length per coil, m (ft.)	18.6 (57.6)
Standard refrigerant line lengths m (ft.)	2.44 (8)

Utilities

Cooling water, flow rate l/min. (gal./min.)	
at 13°C (55°F)	13.6 (3.6)
at 26°C (79°F)	27.3 (7.2)
at 29°C (85°F)	54.1 (14.3)
Power Input, at maximum load, kW	19.2
Nominal Power Requirements ^e	200/3/50 208/3/60 230/3/60 380/3/50 400/3/50 460/3/60 480/3/60 575/3/60
Max Operating Sound Level, dB(A) ^f	68
Minimum Room Volume m ³ (ft. ³) ^g	40 (1400)
Weight, kg (lb)	544 (1200)

Footnotes: (a) Standard conditions for performance testing. (1) Cryocoil environment at 20°C (2) Recommend cryocoils and line lengths (3) Cooling water temperature between 25°C and 28°C. (4) Operation at 60 Hz. (b) Larger cryocoils may give greater pumping speeds, and can be used in some applications. Contact your sales representative or the factory for application details. (c) Standard cryocoil at twenty five percent (25%) of maximum pumping speed. (d) Recommended cryopump start pressure is near normal "crossover." Mechanical roughing pumps and blowers are generally more effective for moisture removal above 1torr. (e) For nominal power requirements not in the table, please contact the factory. Please refer to the manual for operational voltage ranges. For 480 volt operation the maximum voltage is 506. (f) Units were tested in a manufacturing environment while under maximum load in the COOL mode. (g) To comply with the Safety Code for Mechanical Refrigeration, ANSI/ASHRAE-15-1994, the following units should be located in a room no smaller than listed. (h) 5.0 minute maximum defrost is for a 2 m² coil. Most applications use smaller coils and achieve shorter defrost times. A 1 m² coil with standard refrigerant lines will defrost in less than 2 minutes.

MaxCool Dimensions (not to scale)

MaxCool 2500 L

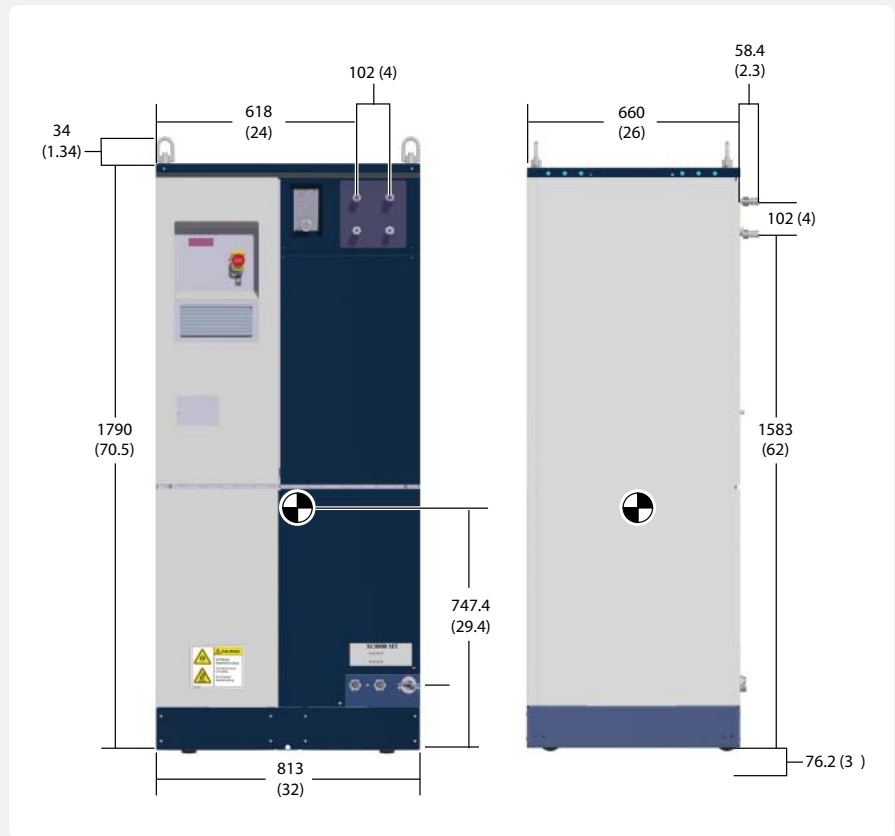
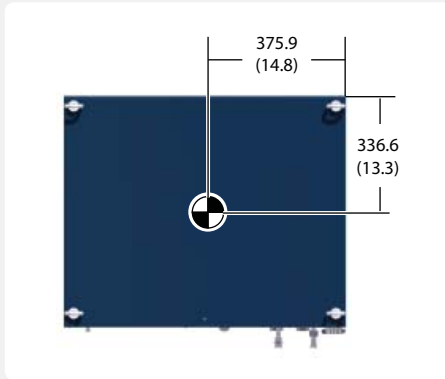

Dual circuit MaxCool models have the same dimensions as the single circuit MaxCool models in the equivalent size unit.

Note: Maximum angle of inclination for shipping or handling all units is forty-five degrees (45°)

For more information, please contact your local Brooks Automation sales representative or visit www.brooks.com.

